

GENERAL DESCRIPTION

LED luminaire for recessed, surface or suspended installation with optional **Mounting Box** and v-hooks, consult factory. Featuring a low profile with high performance, using the most advanced LED technology by delivering up to 130lm/W without glare (edge-lit LED light engine). Diffuser in frosted, opal PMMA. Body made of aluminum extrusion, incorporating light thermal management with passive cooling. Ideal for commercial environments. Field adjustments to be done on site.

CERTIFICATION

Approved to UL1598 and CSA C22.2 No. 250 standards**
Suitable for damp locations.



*LED Five (5) year limited warranty.
**Operating temperature: -20°C to +35°C / -4°F to +95 °F, consult factory for operating temperatures outside the listed range.
***Not all available products are DLC qualified. View DLC Qualified Products List at designlights.org to confirm which versions are qualified.
Specifications are subject to change. Please confirm latest specifications prior to placing order.

PERFORMANCE SUMMARY 14G & 22G AT 4000K

LUMENS(lm)	WATTAGE(W)	EFFICACY(lm/W)
4636	39	119
3794	30	126
2914	23	128

PERFORMANCE SUMMARY 24G AT 4000K

LUMENS(lm)	WATTAGE(W)	EFFICACY(lm/W)
6450	50	129
5547	42	132
4328	32	136



PHOTOMETRIC DATA

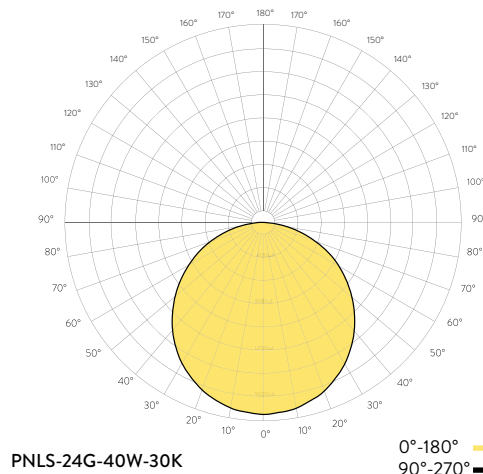

DIMENSIONS

SIZE	L	W	H
14G	4'	1'	0.40"
22G	2'	2'	0.40"
24G	4'	2'	0.40"

MOUNTING / CROSS SECTION

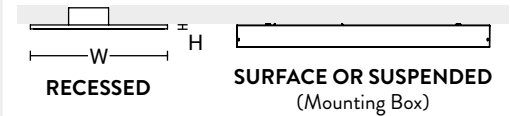

ORDERING INFORMATION

PNLS	SIZE	WATTAGE	CCT	VV	MV3
FIXTURE	SIZE	WATTAGE	CCT	OPTIONS	DRIVER
PNLS = Panel . S	14G = 1' x 4'	36W = 36 Watts (SELECTABLE 20W, 30W, 36W)	35K = 3500K (SELECTABLE 30K-35K-40K)	VV = Variable Wattage, Variable CCT	MV3 = 120V-347V, 10% Dimming (0-10V)
	22G = 2' x 2'				
	24G = 2' x 4'	50W = 50 Watts (SELECTABLE 30W, 40W, 50W)			



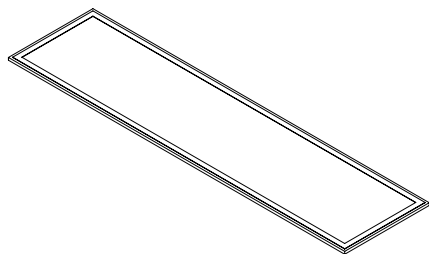

DIMENSIONS

SIZE	L	W	H	H1 (including driver)	MTG L	MTG W
14G	4'	1'	0.40"	1.75"	43.25"	11.00"
22G	2'	2'	0.50"	1.75"	19.00"	22.75"
24G	4'	2'	0.50"	1.75"	37.00"	22.75"

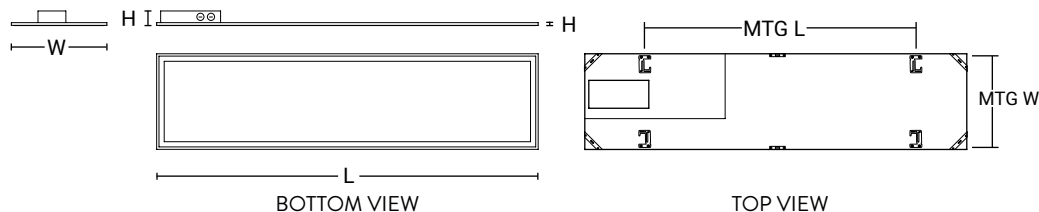

SHIELDING

Impressive uniformity of light distribution with a high transmittance factor. Diffuser in frosted, opal PMMA.

CONSTRUCTION

Made of aluminum extrusion, incorporating light thermal management with passive cooling. **Mounting Box** available for surface or suspended installations, consult factory.

FINISH

High gloss white polyester baked powder coat enamel. Custom colours available for **Mounting Box**, consult factory.



LED LIGHT ENGINE

Edge-lit LED light engine.

LED DRIVER

10% Dimming (0-10V).

ELECTRICAL

3000K 3500K 4000K

120V - 347V

L80 performance at 60,000 hours minimum. 80 CRI Standard. Other dimming options, lumen options, 90CRI and lengths available, consult factory.

CERTIFICATION

Approved to UL1598 and CSA C22.2 No. 250 standards**

Suitable for damp locations.



*LED Five (5) year limited warranty.

**Operating temperature: -20°C to +35°C / -4°F to +95 °F, consult factory for operating temperatures outside the listed range.

***Not all available products are DLC qualified. View DLC Qualified Products List at designlights.org to confirm which versions are qualified.

MOUNTING / CROSS SECTION

Recessed, surface or suspended installation with optional surface mount box and v-hooks, consult factory.

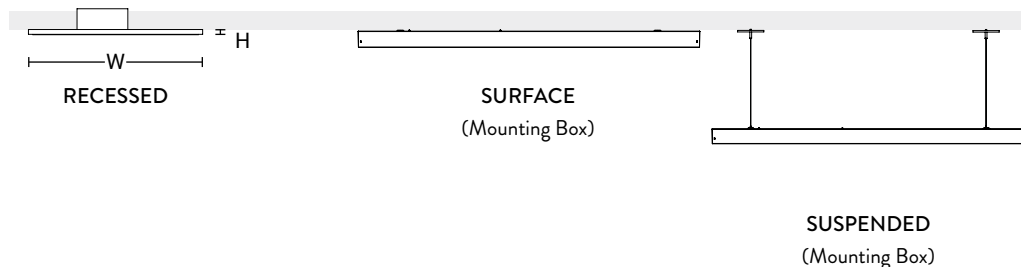

FIELD ADJUSTABLE LIGHT OUTPUT AND CCT

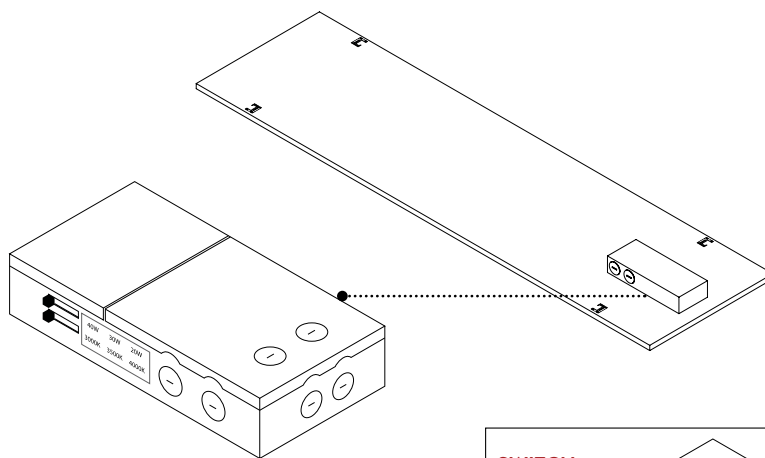

SWITCH

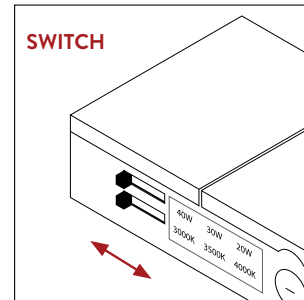

CCT AND WATTAGE

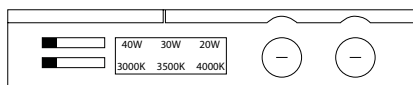

MOUNTING BOX

For surface or suspended installation, our Mounting Box provides a simple and elegant look. It also can be customized to any color to cohesively fit into any environment you can imagine, consult factory for more information.

DIMENSIONS

SIZE	L	W	H	MTG L	MTG W
14G	48.00"	12.19"	2.50"	36.00"	8.00"
22G	24.12"	24.12"	2.50"	18.00"	18.00"
24G	47.87"	24.12"	2.50"	36.00"	18.00"



surface mounting box

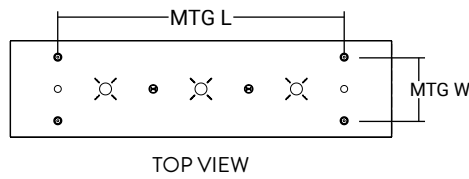
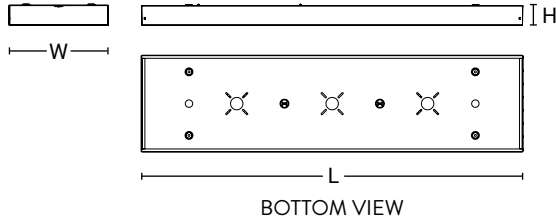

PHOTOMETRIC DATA

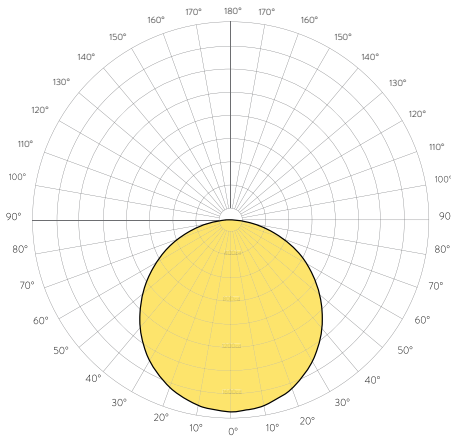

PNLS-24G-40W-30K

Zone	Lumens
0.00°-10.00°	233.61
10.00°-20.00	549.63
20.00°-30.00	833.31
30.00°-40.00	1004.90
40.00°-50.00	1042.98
50.00°-60.00	945.50
60.00°-70.00	731.41
70.00°-80.00	442.94
80.00°-90.00	144.33
90.00°-100.00	8.16
100.00°-110.00	2.95
110.00°-120.00	2.48
120.00°-130.00	2.35
130.00°-140.00	2.68
140.00°-150.00	3.60
150.00°-160.00	4.05
160.00°-170.00	3.21
170.00°-180.00	1.50
0.00°-90.00	5928.62
90.00°-180.00	30.97
0.00°-180.00	5959.59

Mtg Height	Light Level	Beam Diameter
6.0 ft	56.5 fc	18.0 ft
8.0 ft	31.8 fc	24.1 ft
10.0 ft	20.4 fc	30.1 ft
12.0 ft	14.1 fc	36.1 ft
15.0 ft	9.0 fc	45.1 ft

	0.00°	45.00°	90.00°
0.00°	3139	3139	3139
45.00°	2949	2959	2960
55.00°	2851	2851	2858
65.00°	2707	2703	2699
75.00°	2511	2499	2477
85.00°	2225	2160	2108

WATTAGE & EFFICACY: PNLS-22G-36W-35K

Set to: 36W, 30K	4337lm	3000K	39W	111lm/W
Set to: 30W, 30K	3555lm	3000K	31W	117lm/W
Set to: 20W, 30K	2738lm	3000K	23W	122lm/W
Set to: 36W, 35K	4712lm	3500K	38W	124lm/W
Set to: 30W, 35K	3817lm	3500K	30W	127lm/W
Set to: 20W, 35K	2895lm	3500K	23W	129lm/W
Set to: 36W, 40K	4636lm	4000K	39W	119lm/W
Set to: 36W, 40K	3795lm	4000K	30W	126lm/W
Set to: 20W, 30K	2914lm	4000K	23W	128lm/W

WATTAGE & EFFICACY: PNLS-24G-50W-35K

Set to: 50W, 30K	6041lm	3000K	50W	121lm/W
Set to: 40W, 30K	5198lm	3000K	42W	123lm/W
Set to: 30W, 30K	4059lm	3000K	32W	127lm/W
Set to: 50W, 35K	6407lm	3500K	49W	131lm/W
Set to: 40W, 35K	5479lm	3500K	41W	134lm/W
Set to: 30W, 35K	4239lm	3500K	31W	135lm/W
Set to: 50W, 40K	6449lm	4000K	50W	129lm/W
Set to: 40W, 40K	5546lm	4000K	42W	132lm/W
Set to: 30W, 40K	4328lm	4000K	32W	136lm/W