

RQ1-0X

RQ . 1 opening

PROJECT:
CAT.NO:
NOTES:

DATE:
TYPE:
VOLTS:

ARCLUX[®]
SERIES

GENERAL DESCRIPTION

LED luminaire for **suspended** installation with aircraft cables or **surface** installation. Provides a choice of direct or indirect light distribution allowing a superior quality of soft lighting. Frosted acrylic lens down and prismatic lens up (if required) supplied as standard. with one-piece rigid body constructed from code gauge steel. Ideal for commercial or architectural environments. Row mounting available, consult factory.

CERTIFICATION

Approved to UL1598 and CSA C22.2 No. 250 standards**
Suitable for damp locations.



*LED Five (5) year limited warranty.

**Operating temperature: -20°C to +35°C / -4°F to +95 °F, consult factory for operating temperatures outside the listed range.

Specifications are subject to change. Please confirm latest specifications prior to placing order.



PERFORMANCE SUMMARY

DISTRIBUTION 5U5 (50% UP / 50% DOWN) 4FT AT 4000K

LUMENS(lm)	WATTAGE(W)	EFFICACY(lm/W)
4000	40	94

DISTRIBUTION DIR (100% DOWN) 4FT AT 4000K

LUMENS(lm)	WATTAGE(W)	EFFICACY(lm/W)
4000	47	112

DISTRIBUTION IND (100% UP) 4FT AT 4000K

LUMENS(lm)	WATTAGE(W)	EFFICACY(lm/W)
4000	31	121

PHOTOMETRIC DATA

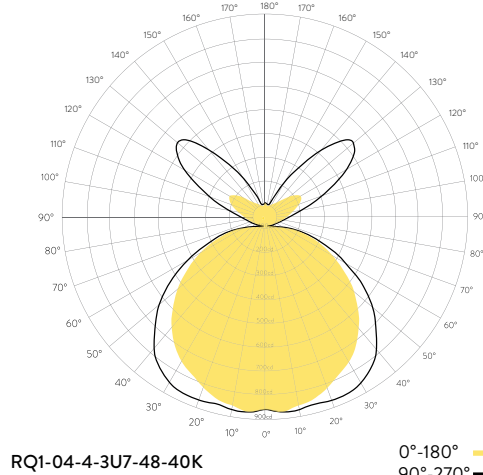

DIMENSIONS

SIZE	L	W	H
4FT	44.00"	8.50"	1.65"
8FT	92.25"	8.50"	1.65"

MOUNTING / CROSS SECTION

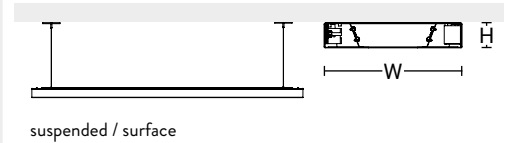

ORDERING INFORMATION

FIXTURE	OPENING	DISTRIBUTION	LENGTH	LUMENS	CCT	FINISH	MOUNTING *OPTIONAL*	POWER CORD *OPTIONAL*	DRIVER
RQ1 = RQ . 1 opening	02 = 2"	5U5 = 50% Up / 50% Down	4 = 4ft	32 = 3200lm	30K = 3000K	GLOSSY W = White Housing	A4 = 48in Aircraft Cable	C1 = 5ft Cord	MV = Standard 120V-277V, 1% Dimming (0-10V)
	03 = 3"	6U4 = 60% Up / 40% Down		40 = 4000lm	35K = 3500K		B = Black Housing	A5 = 60in Aircraft Cable	C2 = 6ft Cord
RQ1 = RQ . 1 opening	04 = 4"	4U6 = 40% Up / 60% Down	8 = 8ft	60 = 6000lm	40K = 4000K	G = Grey Housing	A8 = 96in Aircraft Cable	C4 = 9ft Cord	EM = Emergency Driver
		7U3 = 70% Up / 30% Down		64 = 6400lm	TW = Tunable White		A12 = 144in Aircraft Cable	C7 = 13ft Cord	X = DALI, Lutron EcoSystem LED, and other drivers available, consult factory
		3U7 = 30% Up / 70% Down		80 = 8000lm	*Other CCT, RGB (Red, Green, Blue LEDs), DM (dim to warm) available, consult factory				
		DIR = 100% Down		96 = 9600lm					
		IND = 100% Up		120 = 12000lm					
		*Custom distribution available, consult factory							
						BM = Black Housing			
						GM = Grey Housing			
						X = other colours and finishes available, consult factory		X = row mounting available, consult factory	

RQ1-0X

RQ . 1 opening

PROJECT:
CAT.NO:
NOTES:

DATE:
TYPE:
VOLTS:

ARCLUX[®]
SERIES

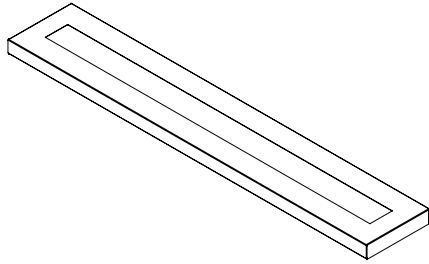

DIMENSIONS

SIZE	L	W	H	MTG L	MTG W
4FT	44.00"	8.50"	1.65"	41.00"	4.25"
8FT	92.25"	8.50"	1.65"	85.25"	4.25"

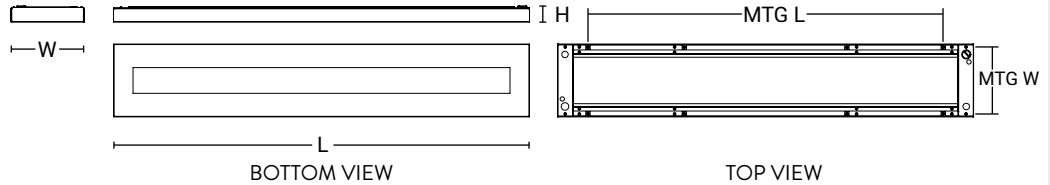

SHIELDING

Frosted acrylic lens down and prismatic lens up (if required) supplied as standard.

CONSTRUCTION

One-piece rigid body constructed from code gauge steel.

FINISH

Standard finish is high gloss white polyester baked powder coat enamel. Custom colours available, consult factory.

Glossy / Matte / Custom Colours



LED LIGHT ENGINE

Mounted on internal high reflectance white painted reflector.

LED DRIVER

1% Dimming (0-10V). Emergency driver available. DALI (Digital Addressable Lighting Interface), Lutron EcoSystem LED, and other drivers available, consult factory.

ELECTRICAL

3000K 3500K 4000K

120V - 277V 347V

*TW (Tunable White), other CCT, RGB (Red, Green, Blue LEDs), DM (dim to warm) available, consult factory. L80 performance at 60,000 hours minimum. 80 CRI Standard. Other dimming options, lumen options, 90CRI and lengths available, consult factory.

CERTIFICATION

Approved to UL1598 and CSA C22.2 No. 250 standards** Suitable for damp locations.



*LED Five (5) year limited warranty.

**Operating temperature: -20°C to +35°C / -4°F to +95 °F, consult factory for operating temperatures outside the listed range.

MOUNTING / CROSS SECTION

Suspended installation with aircraft cables or surface installation.

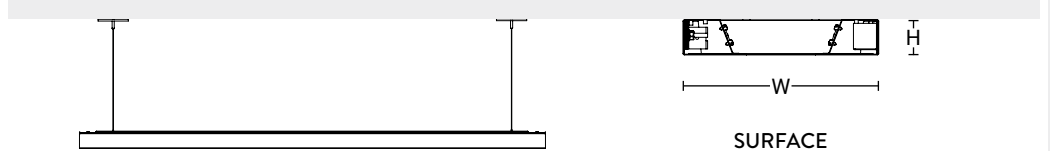

SUSPENDED
(with aircraft cables)

JOINING DETAIL / ROW MOUNTING

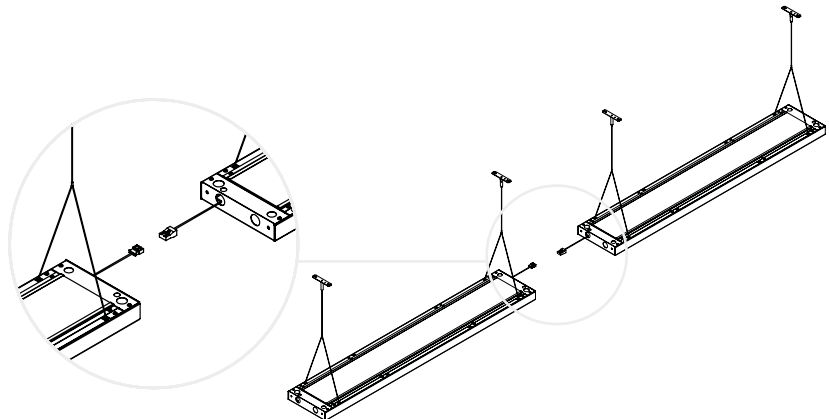

SUSPENDED - 30% UP / 70% DOWN (3U7)

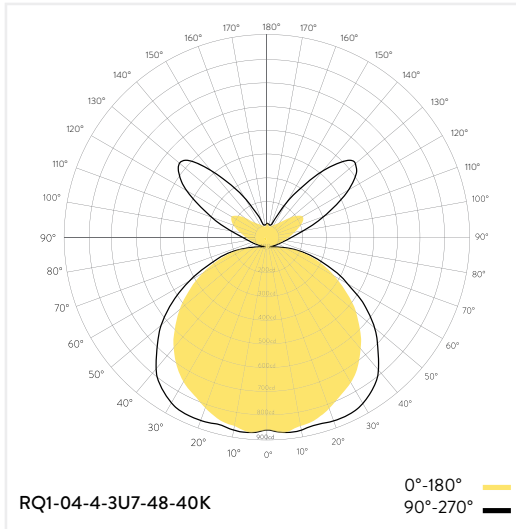

ZONAL LUMEN SUMMARY

Zone	Lumens
0.00°-10.00°	96.93
10.00°-20.00	236.82
20.00°-30.00	376.63
30.00°-40.00	478.32
40.00°-50.00	513.12
50.00°-60.00	477.48
60.00°-70.00	380.83
70.00°-80.00	255.88
80.00°-90.00	109.55
90.00°-100.00	20.06
100.00°-110.00	66.91
110.00°-120.00	178.26
120.00°-130.00	298.65
130.00°-140.00	294.19
140.00°-150.00	180.78
150.00°-160.00	86.76
160.00°-170.00	34.58
170.00°-180.00	11.51
0.00°-90.00	2925.56
90.00°-180.00	1171.69
0.00°-180.00	4097.25

CONE OF LIGHT

Mtg Height	Light Level	Beam Diameter
6.0 ft	23.5 fc	5.7 ft
8.0 ft	13.2 fc	7.6 ft
10.0 ft	8.5 fc	9.5 ft
12.0 ft	5.9 fc	11.4 ft
15.0 ft	3.8 fc	14.2 ft

AVERAGE LUMINAIRE LUMINANCE (CD/M2)

	0.00°	45.00°	90.00°
0.00°	3214	3214	3214
45.00°	3170	3053	3198
55.00°	3083	2844	2979
65.00°	2959	2515	2536
75.00°	2947	2125	2050
85.00°	3252	1501	1284

WATTAGE & EFFICACY - DISTRIBUTION 5U5 (50% UP / 50% DOWN)

RQ1-03-5U5-4-32-40K	3200lm	4000K	31W	91lm/W
RQ1-03-5U5-4-40-40K	4000lm	4000K	40W	94lm/W
RQ1-03-5U5-4-48-40K	4800lm	4000K	48W	94lm/W
RQ1-03-5U5-4-60-40K	6000lm	4000K	66W	96lm/W
RQ1-03-5U5-8-32-40K	3200lm	4000K	62W	91lm/W
RQ1-03-5U5-8-40-40K	4000lm	4000K	80W	94lm/W
RQ1-03-5U5-8-48-40K	4800lm	4000K	96W	94lm/W
RQ1-03-5U5-8-60-40K	6000lm	4000K	132W	96lm/W

WATTAGE & EFFICACY - DISTRIBUTION DIR (100% DOWN)

RQ1-03-DIR-4-32-40K	3200lm	4000K	37W	106lm/W
RQ1-03-DIR-4-40-40K	4000lm	4000K	47W	112lm/W
RQ1-03-DIR-4-48-40K	4800lm	4000K	61W	112lm/W
RQ1-03-DIR-4-60-40K	6000lm	4000K	68W	112lm/W
RQ1-03-DIR-8-32-40K	3200lm	4000K	74W	106lm/W
RQ1-03-DIR-8-40-40K	4000lm	4000K	94W	112lm/W
RQ1-03-DIR-8-48-40K	4800lm	4000K	122W	112lm/W
RQ1-03-DIR-8-60-40K	6000lm	4000K	136W	112lm/W

WATTAGE & EFFICACY - DISTRIBUTION IND (100% UP)

RQ1-03-IND-4-32-40K	3200lm	4000K	26W	114lm/W
RQ1-03-IND-4-40-40K	4000lm	4000K	31W	121lm/W
RQ1-03-IND-4-48-40K	4800lm	4000K	37W	122lm/W
RQ1-03-IND-4-60-40K	6000lm	4000K	48W	121lm/W
RQ1-03-IND-8-32-40K	3200lm	4000K	52W	114lm/W
RQ1-03-IND-8-40-40K	4000lm	4000K	62W	121lm/W
RQ1-03-IND-8-48-40K	4800lm	4000K	74W	122lm/W
RQ1-03-IND-8-60-40K	6000lm	4000K	96W	121lm/W