

GENERAL DESCRIPTION

LED luminaire for surface installation. Snap-in frosted acrylic lens with a rigid one-piece body constructed from code gauge steel. Ideal for commercial environments. Row mounting available, consult factory.

CERTIFICATION

Approved to UL1598 and CSA C22.2 No. 250 standards**
Suitable for damp locations.



*LED Five (5) year limited warranty.
**Operating temperature: -20°C to +35°C / -4°F to +95 °F, consult factory for operating temperatures outside the listed range.
***Not all available products are DLC qualified. View DLC Qualified Products List at designlights.org to confirm which versions are qualified.
Specifications are subject to change. Please confirm latest specifications prior to placing order.

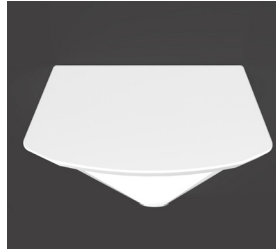

ELECTRICAL

3000K 4000K 5000K

120V - 347V

L80 performance at 60,000 hours minimum.
80 CRI Standard. Other dimming options, lumen options, 90CRI and lengths available, consult factory.

FINISH

High gloss white polyester baked powder coat enamel.



PHOTOMETRIC DATA

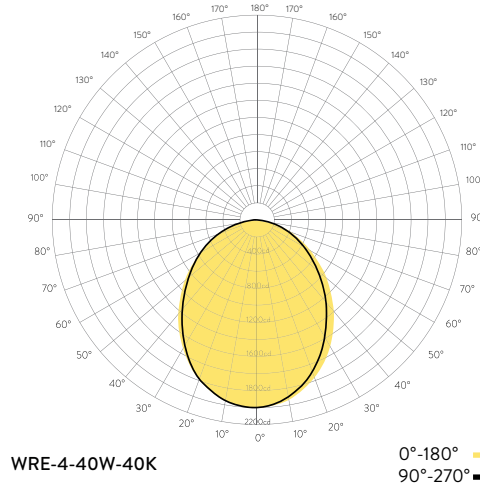

DIMENSIONS

SIZE	L	W	H
4FT	47.50"	5.38"	2.50"

MOUNTING / CROSS SECTION

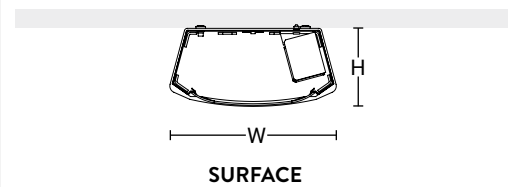

ORDERING INFORMATION

WRE	4	40W		MV3
FIXTURE	LENGTH	WATTAGE	CCT	DRIVER
WRE = WR. Evalux	4 = 4 ft	40W = 40 Watts	30K = 3000K 40K = 4000K 50K = 5000K	MV3 = Standard 120V-347V, 10% Dimming (0-10V)

PERFORMANCE SUMMARY AT 3000K

LUMENS(lm)	WATTAGE(W)	EFFICACY(lm/W)
5000	40	125

PERFORMANCE SUMMARY AT 4000K

LUMENS(lm)	WATTAGE(W)	EFFICACY(lm/W)
5000	40	125

PERFORMANCE SUMMARY AT 5000K

LUMENS(lm)	WATTAGE(W)	EFFICACY(lm/W)
5000	40	125

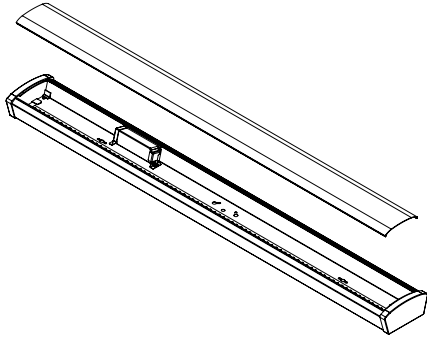

DIMENSIONS

SIZE	L	W	H	MTG L	MTG W
4FT	47.50"	5.38"	2.50"	30.00"	1.40"

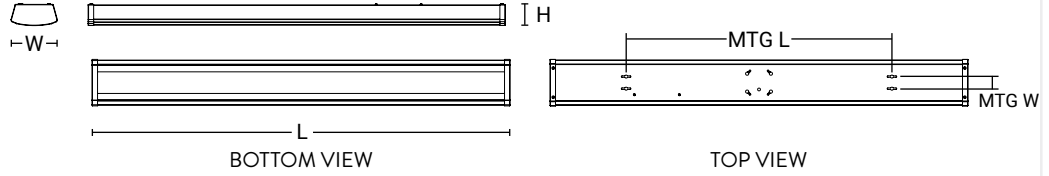

SHIELDING

Snap-in frosted acrylic lens.

CONSTRUCTION

Rigid one-piece body constructed from code gauge steel.

FINISH

High gloss white polyester baked powder coat enamel.



LED LIGHT ENGINE

Mounted on internal high reflectance white painted reflector.

LED DRIVER

10% Dimming (0-10V).

ELECTRICAL

3000K 4000K 5000K

120V - 347V

L80 performance at 60,000 hours minimum.
80 CRI Standard. Other dimming options, lumen options, 90CRI and lengths available, consult factory.

CERTIFICATION

Approved to UL1598 and CSA C22.2 No. 250 standards**
Suitable for damp locations.



*LED Five (5) year limited warranty.

**Operating temperature: -20°C to +35°C / -4°F to +95 °F, consult factory for operating temperatures outside the listed range.

***Not all available products are DLC qualified. View DLC Qualified Products List at designlights.org to confirm which versions are qualified.

MOUNTING / CROSS SECTION

Surface installation on ceiling.

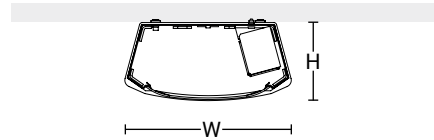

PHOTOMETRIC DATA

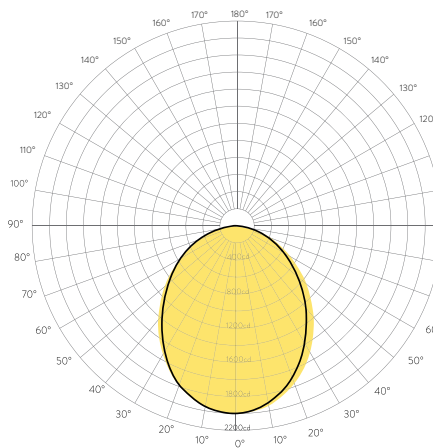

WRE-4-40W-40K

0°-180° — Yellow
90°-270° — Black

ZONAL LUMEN SUMMARY

Zone	Lumens
0.00°-10.00°	49.00
10.00°-20.00	145.94
20.00°-30.00	238.77
30.00°-40.00	321.35
40.00°-50.00	383.92
50.00°-60.00	412.17
60.00°-70.00	383.73
70.00°-80.00	266.94
80.00°-90.00	69.87
90.00°-100.00	32.88
100.00°-110.00	186.62
110.00°-120.00	328.46
120.00°-130.00	382.30
130.00°-140.00	358.94
140.00°-150.00	296.38
150.00°-160.00	218.45
160.00°-170.00	133.38
170.00°-180.00	44.84
0.00°-90.00	2271.70
90.00°-180.00	1982.26
0.00°-180.00	4253.96

CONE OF LIGHT

Mtg Height	Light Level	Beam Diameter
6.0 ft	14.0 fc	0.0 ft
8.0 ft	7.9 fc	0.0 ft
10.0 ft	5.0 fc	0.0 ft
12.0 ft	3.5 fc	0.0 ft
15.0 ft	2.2 fc	0.0 ft

AVERAGE LUMINAIRE LUMINANCE (CD/M2)

	0.00°	45.00°	90.00°
0.00°	2095	2095	2095
45.00°	2379	2825	3412
55.00°	2524	3117	3972
65.00°	2592	3316	4595
75.00°	2416	2985	4519
85.00°	1245	1003	1581

WATTAGE & EFFICACY

WRE-4-40W-30K-MV3	5000lm	3000K	40W	125lm/W
WRE-4-40W-40K-MV3	5000lm	4000K	40W	125lm/W
WRE-4-40W-50K-MV3	5000lm	5000K	40W	125lm/W